

ViaLiteHD

Summary alarm module

User Guide

HRC-2-HB-1

CR2829

01/03/2011



Instrument Care and Safety Information

Please read the whole of this section before using your **ViaLiteHD** product. It contains important safety information and will enable you to get the most out of your Fibre Optic Link.

Electrical Safety



The **ViaLiteHD** rack chassis is a Safety Class 1 product (having metal chassis directly connected to earth via the power supply cable).

When operating the equipment note the following precautions:

- Hazardous voltages exist within the equipment. There are no user serviceable parts inside; the covers should only be removed by a qualified technician.
- There are no user replaceable fuses in the rack chassis mounted equipment. Replacement should only be carried out by a PPM technician.
- The rack chassis earth stud SHOULD be connected to the safety earth.
- When using a 2 pin power supply cable the rack chassis earth stud MUST be connected to the safety earth.
- The **ViaLiteHD** Power Supply Modules do not have an isolating switch on the mains voltage inlet. For this reason, the **ViaLiteHD** Rack Chassis must be installed within easy reach of a clearly labelled dual pole mains isolation switch, which supplies the equipment.

ESD Precautions

The **ViaLiteHD** RF Fibre Optic Link is equipped with high frequency active electronics, without the correct handling they will be susceptible to damage.



Precautions for handling electro-static sensitive devices should be observed when handling all **ViaLiteHD** modules. Technicians should ensure that they use effective personal grounding (i.e. ESD wrist strap etc.) when servicing the equipment. Any equipment or tools used should be grounded to prevent static charge build-up. Good practice should be observed at all times for reference see relevant standards.

EN 61340-5-1, Protection of Electronic Devices from Electrostatic Phenomena . General Requirements+

Optical Safety



The **ViaLiteHD** RF Fibre Optic Transmitters, Dual Transmitters and Transceivers contain optical sources (usually laser diodes) operating at nominal wavelengths of 1270nm to 1610nm.

These devices are rated as EN60825-1:2007 as CLASS 1 radiation emitting devices. A class 1 laser is safe under all conditions of normal use.

When operating the equipment note the following precautions:

- Never look into the end of an optical fibre directly or by reflection either with the naked eye or through an optical instrument.
- Never leave equipment with radiating bare fibres . always cap the connectors.
- Do not remove equipment external covers when operating.

Hot surface



The **ViaLiteHD** Summary alarm module may have hot surfaces when operating under full load. The hot surfaces are not accessible when fitted in an approved rack chassis installation.

Suitable precaution should be taken when handling this device.

- Allow to cool for 10 minutes
- Do not touch metallic surfaces or printed circuit board when hot.
- When handling, hold front panel and handle only.

TABLE OF CONTENTS

1	INTRODUCTION	5
1.1	Internal architecture	5
1.2	Typical deployment	6
1.3	<i>ViaLiteHD</i> and <i>ViaLite</i> Classic compatibility	6
2	SUMMARY ALARM MODULE, PHYSICAL INTERFACES	7
2.1	Module operation, 7HP standard plug-in module	7
2.2	Front panel	8
2.2.1	Front panel, visual indicators	8
2.2.2	Front panel, reset switch	8
2.2.3	Front panel, buzzer	8
2.2.4	Front panel, acknowledge switch	8
2.2.4.1	Front panel, acknowledge switch, slot alarm active, with I2C response, fail module.....	8
2.2.4.2	Front panel, acknowledge switch, slot alarm active, with no I2C response, removed module.....	9
2.2.4.3	Front panel, acknowledge switch, slot alarm inactive, with I2C response, replaced module.....	9
2.2.4.4	Front panel, acknowledge switch, slot alarm inactive, with no I2C response, fail module.....	9
2.3	Rear panel	9
2.3.1	Rear panel, module rear connections	9
2.3.2	Rear panel, backplane relay connection	9
2.4	User configuration DIP switches	10
2.4.1	User configuration DIP switches, alarm masking SW2 and SW3	10
2.4.2	User configuration DIP switches, load resistors SW5	11
3	SETTING UP THE SUMMARY ALARM MODULE	12
3.1	Default configuration	12
3.2	Setting the Alarm masking, manual mode	12
3.3	Setting the Alarm masking, automatic mode	12
3.4	Setting the load DIP switches	12
3.5	Connecting to the rear relay connections	12
4	SYSTEM INTEGRATION	13
4.1	Initial set up equipment	13
4.2	Site requirements	13
5	MECHANICAL DIMENSIONS	14
6	PART NUMBERING	15
7	TECHNICAL SPECIFICATIONS	16
8	MAINTENANCE AND FAULT-FINDING GUIDE	17
9	GLOSSARY	18
10	PRODUCT WARRANTY	19

1 Introduction

The **ViaLiteHD** Summary alarm module is used to monitor **ViaLiteHD** equipment fitted in the same rack. It is able to report alarms by front panel visual indication, audio alarm and by status of its on board relays. There are two form C relays, both accessible at the rear of the module; one relay is also routed to the cabinet backplane.

The summary alarm module maybe configured, so that its on board processor automatically senses and alarm only active module; or it may be configured via manual DIP switches. both monitoring and controlling modules

The module has an on board resistive load, this can be configured via DIP switches to ensure the power supplies meet their minimum load requirement. See your **ViaLiteHD** Rack Handbook for more details.

1.1 Internal architecture

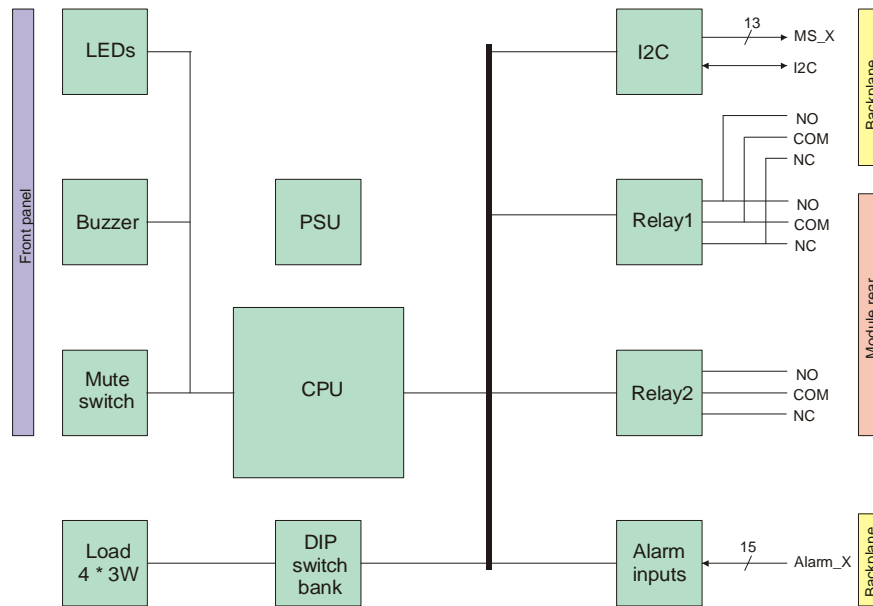

Key features are:

- The CPU monitors all rack alarm outputs
- The CPU controls all module outputs
- The module fits in **ViaLiteHD** rack chassis 7HP slot, HRK3 slot 14
- DIP switches available for manual alarm screening, slots 1-13 and slots 15,16
- I2C bus is used at start up to monitor active slots for automatic alarm masking
- Two dry contact relays, both accessible on module rear connector, one wired in parallel to the rack chassis connector
- Alarms are latched, they will continue to be reported until they are acknowledged
- Front panel LED indication of rack summary status.
- Front panel buzzer, giving audio alarm when fault is active
- Front panel ACKNOWLEDGE switch
- Different indication for active ALARM and acknowledged ALARM
- The DC input power feed (+12 volts) is protected by a set resettable fuse.
- The internal 5V is generated by linear regulator

1.2 Typical deployment

The Summary alarm module is typically deployed as part of a 3U rack chassis based equipment solution. It can however be fitted in a range of other equipment.

When fitted in an HRK3 rack chassis it must be fitted in slot 14, this is the only slot to have communication with all other slots.



1.3 *ViaLiteHD* and *ViaLite Classic* compatibility

The *ViaLiteHD* summary alarm module will not control or monitor *ViaLite Classic* equipment.

Its dry contact relay circuits will be compatible with circuits used on previous *ViaLite Classic* equipment.

2 Summary alarm module, physical interfaces

This section describes the connections between your *ViaLiteHD* modules and the Summary alarm module. There is no need to install any interface cables between summary alarm module and connected modules, as these are all connected via the rack chassis backplane. Please read full all relevant documents for information on installing your *ViaLiteHD* equipment before commissioning your system.

2.1 Module operation, 7HP standard plug-in module

All *ViaLiteHD* plug-in modules are hot-swappable, so it is not necessary to power-down the rack chassis before inserting a module. All electrical connectors are retained by the module. So it is necessary to either disconnect any cables or have a sufficiently long service loop.

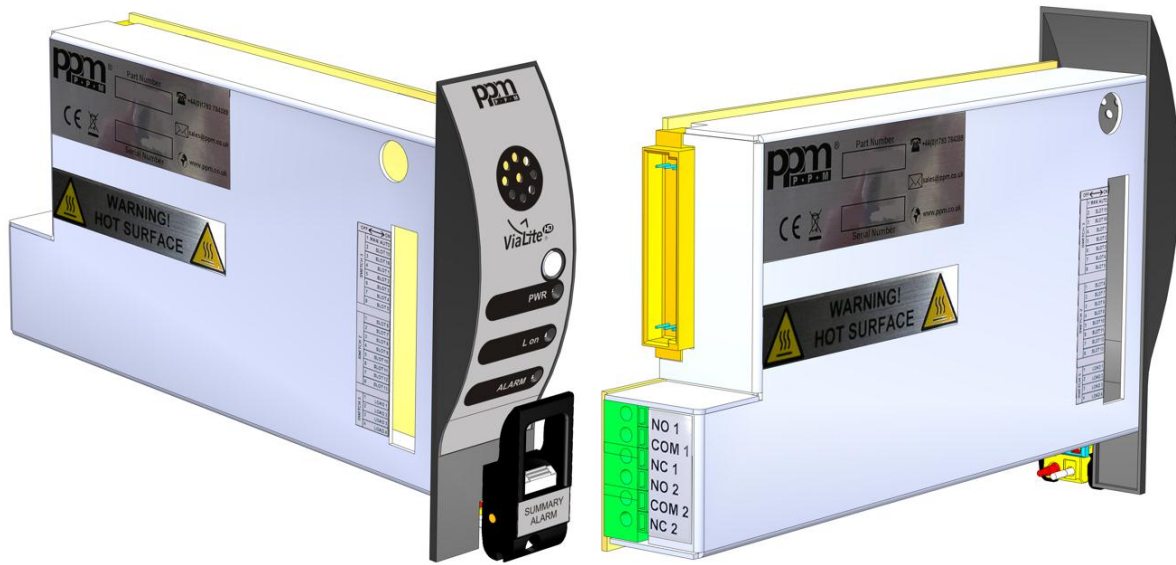

To install a 7HP Standard module

- Push the release button of the module handle down and simultaneously pull the top of the handle forwards.
- Align the module upright and perpendicular to the front face of the rack chassis so that the PCB slides into the $\frac{1}{8}$ inch front card guides top and bottom.
- Gently push the module down its guide, applying pressure via the handle, you may also apply pressure between the LED and buzzer.
- As the module is fully mated the top of the handle should snap back and lock in position.
- The pawls of the handle should be fully engaged in the matching slots.
- If power is applied to the rack chassis the module power LED should light as soon as the module is fully inserted
- Connect any interface cables



To remove a 7HP Standard module

- Disconnect any cables if necessary
- Push the release button of the module handle down and simultaneously pull the top of the handle forwards.

Apply pressure via the handle and gently withdraw the module from the rack chassis.

2.2 Front panel

2.2.1 Front panel, visual indicators

The summary alarm plug-in module has three front panel LEDs for indication of the state of the module. The following table shows the operation of the front panel LEDs which are dependent on module type.

	Colour	SNMP and Web controller
LED1	GREEN	Normal
	No light	No power
LED2	GREEN	Normal
	Solid RED	ALARM, acknowledged
	Flashing RED	ALARM, active
LED3	GREEN	LOAD ON (Any load resistor active)
	No light	LOAD OFF

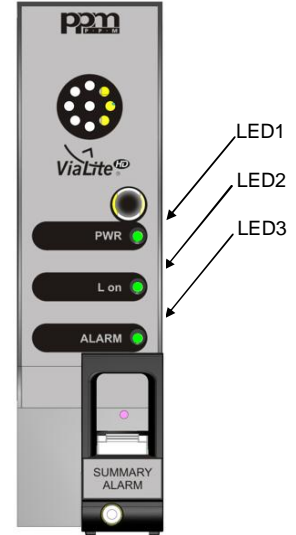

2.2.2 Front panel, reset switch

The hard reset switch is accessible via a small hole behind the handle. Under all normal operating circumstances it should not be required. Actuating the hard reset will cause the module to reboot, the rack inventory table will be deleted.

2.2.3 Front panel, buzzer

The summary alarm plug-in module has a front panel mounted buzzer for indication of the modules state. The following table shows the operation of the buzzer.

Buzzer	SNMP and Web controller
OFF	No ALARM or ALARM acknowledged
ON	ALARM active

The buzzer operates with a nominal frequency of 2.4kHz, the tone is modulated.

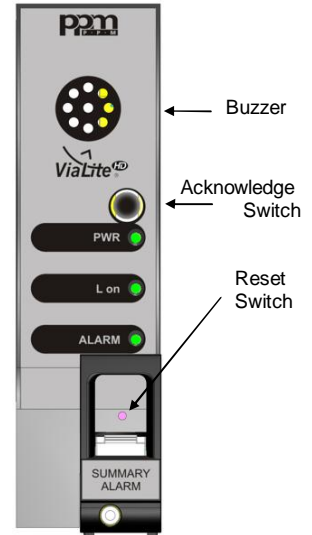

2.2.4 Front panel, acknowledge switch

The ACKNOWLEDGE switch is housed on the front panel, this is used to acknowledge alarms. It works in a number of different modes after the alarm is generated depending on the status of the slot module when the acknowledge switch is hit.

After the ACKNOWLEDGE switch is pressed the summary alarm card will continue to monitor for further alarms.

2.2.4.1 Front panel, acknowledge switch, slot alarm active, with I2C response, fail module

In this state the summary alarm module assumes that a faulty module is fitted in the slot. After pressing the ACKNOWLEDGE switch the BUZZER is MUTED and the STATUS LED is in ALARM acknowledged state (see section 2.2.1). The status of the relays remains unchanged.

2.2.4.2 Front panel, acknowledge switch, slot alarm active, with no I2C response, removed module

In this state the summary alarm module assumes that a faulty module has been removed. After pressing the ACKNOWLEDGE switch the BUZZER is OFF and the STATUS LED is in normal state (see section 2.2.1). The relay will be in its normal state.

2.2.4.3 Front panel, acknowledge switch, slot alarm inactive, with I2C response, replaced module

In this state the summary alarm module assumes that a faulty module has been replaced. After pressing the ACKNOWLEDGE switch the BUZZER is OFF and the STATUS LED is in normal state (see section 2.2.1). The relay will be in its normal state.

2.2.4.4 Front panel, acknowledge switch, slot alarm inactive, with no I2C response, fail module

In this state the summary alarm module assumes that a faulty module is fitted in the slot. After pressing the ACKNOWLEDGE switch the BUZZER is MUTED and the STATUS LED is in ALARM acknowledged state (see section 2.2.1). The status of the relays remains unchanged.

2.3 Rear panel

2.3.1 Rear panel, module rear connections

The rear panel provides interconnections for two dry contact relays. These maybe accessed via the connector J2. Both relays are triggered by the same condition signal, but they are electrically isolated. All the pins are volt free.

The module has a 6-pin connector; this is available at the rear of the module.

The three connections for each relay are

- NO - Normally open
- COM - Common
- NC - Normally closed

Connections from Relay 1 are also connected in parallel to the rack chassis backplane.

The rear panel provides interconnections for two dry contact relays. The many be accessed via a six way screwless connector, it is suitable for use with 14 . 22 AWG wire

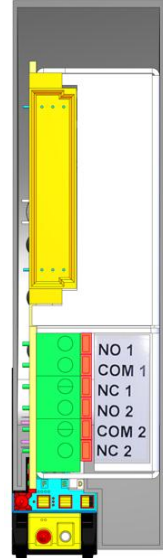

J2	Name	ALARM = OFF	ALARM = ON
Pin 1	NO_1	Relay 1 NO1 is open circuit NC1 is shorted to COM1	Relay 1 NC1 is open circuit NO1 is shorted to COM1
Pin 2	COM_1		
Pin 3	NC_1		
Pin 4	NO_2	Relay 2 NO2 is open circuit NC2 is shorted to COM2	Relay 2 NC2 is open circuit NO2 is shorted to COM2
Pin 5	COM_2		
Pin 6	NC_2		

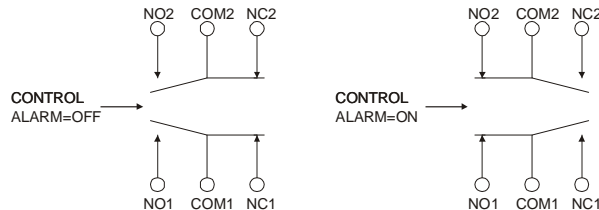

2.3.2 Rear panel, backplane relay connection

Relay 1 is connected in parallel to the backplane, making it available on the rack chassis connector. See your rack chassis handbook.

2.4 User configuration DIP switches

The summary alarm card is fitted with DIP switch allow you to configure the module. It has two eight way DIP switches (SW2 and SW3), that configures the alarm operation and one four way DIP switch (SW5) that configures the load.

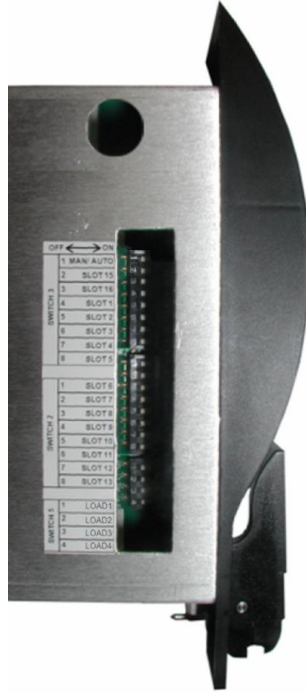

2.4.1 User configuration DIP switches, alarm masking SW2 and SW3

Eight way DIP switches SW2 and SW3 configure the alarm operation.

SW3	Name	OFF	ON
Position 1	Automatic/Manual	Automatic masking	Manual masking
Position 2	Slot 15 (PS 1)	Normal operation	Slot 15 alarms masked
Position 3	Slot 16 (PS 2)	Normal operation	Slot 16 alarms masked
Position 4	Slot 1	Normal operation	Slot 1 alarms masked
Position 5	Slot 2	Normal operation	Slot 2 alarms masked
Position 6	Slot 3	Normal operation	Slot 3 alarms masked
Position 7	Slot 4	Normal operation	Slot 4 alarms masked
Position 8	Slot 5	Normal operation	Slot 5 alarms masked

SW2	Name	OFF	ON
Position 1	Slot 6	Normal operation	Slot 6 alarms masked
Position 2	Slot 7	Normal operation	Slot 7 alarms masked
Position 3	Slot 8	Normal operation	Slot 8 alarms masked
Position 4	Slot 9	Normal operation	Slot 9 alarms masked
Position 5	Slot 10	Normal operation	Slot 10 alarms masked
Position 6	Slot 11	Normal operation	Slot 11 alarms masked
Position 7	Slot 12	Normal operation	Slot 12 alarms masked
Position 8	Slot 13	Normal operation	Slot 13 alarms masked

When in automatic mode, manual alarm masking DIP switches (SW2 positions 1-8, SW3 positions 2-8) are ignored.

When operating in automatic mode the module executes the following procedure to determine which slots to mask, typically these will be empty slots. It is important when powering up a

1. After power is applied the module waits for all other cards to boot
2. It then sequentially poles the I2C bus of each slot to determine if that slot is occupied
 - o If that slot responds to the I2C, the inventory for that slot has the module type added, the alarm for this slot is active
 - o If that slot does not respond, the inventory for that slot is marked as empty, the alarm for this slot is masked (inactive)
3. Only active alarms are reported

After power up the module will also run periodic inventory updates to check if new modules are added

2.4.2 User configuration DIP switches, load resistors SW5

This function is provided to ensure that when redundant power supplies are used, there is enough current for both power supplies to be active. The module can provide a maximum load of 12 watts load, this load can be switched in 3 watt steps

Load	0 / 3 / 6 / 9 / 12 watts switched
Control	via switch selection, using four DIP switches, see section 2.4
Setting*	1 or 2 modules fitted all four switches ON
	3 or 4 modules fitted three switches ON
	5 or 6 modules fitted two switches ON
	7 or 8 modules fitted one switch ON
	9 or more modules fitted

* These calculations assume the lowest possible power consumption to meet the minimum load specification, a more accurate calculation can be made by using the modules datasheets or handbooks.

SW5	Name	OFF	ON
Position 1	Load 1	Load resistor OFF	Load resistor ON
Position 2	Load 2	Load resistor OFF	Load resistor ON
Position 3	Load 3	Load resistor OFF	Load resistor ON
Position 4	Load 4	Load resistor OFF	Load resistor ON

The **ViaLiteHD** Summary alarm module module may have hot surfaces when operating under full load. Suitable precaution should be taken when handling this device, see safety instructions

3 Setting up the summary alarm module

Your summary alarm module is delivered fully configured and ready to work. Below are details of how to change from these default configurations

3.1 Default configuration

The module is delivered with the following configuration.

ALARM MASKING	AUTOMATIC
MANUAL MASK	all slots OFF
LOAD switches	all OFF

3.2 Setting the Alarm masking, manual mode

Details of the DIP switch positions are given in section 2.4.1. If you wish to configure your module to have alarms manually masked follow the sequence below. Any masked slot will have its alarm output ignored. Unpopulated slots will generate alarms, therefore these should be masked. DIP switches can be accessed with the module partially withdrawn.

1. Set SW3 position 1 to OFF, this configures the module for manual alarm masking
2. Each slot that you wish to mask the alarm of be should be set to ON, using DIP switches SW2 and SW3

3.3 Setting the Alarm masking, automatic mode

Details of the DIP switch positions are given in section 2.4.1. If you wish to configure your module to have alarms automatically masked follow the sequence below. Any masked slot will have its alarm output ignored. DIP switches can be accessed with the module partially withdrawn.

1. Set SW3 position 1 to ON, this configures the module for manual alarm masking
2. Each slot that you wish to mask the alarm of be should be set to ON, using DIP switches SW2 and SW3

Unpopulated slots will not respond to the I2C pole therefore these will all be masked. When in automatic mode, manual alarm masking DIP switches (SW2 positions 1-8, SW3 positions 2-8) are ignored

3.4 Setting the load DIP switches

Detail of the DIP switch positions are given in section 2.4.2. If you wish to activate any of the resistive loads follow the sequence below. DIP switches can be accessed with the module partially withdrawn.

1. Calculate the additional load required, see section 2.4.2.
2. Round this load up to the nearest three watt step
3. Switch the appropriate number of DIP switches of SW5 to the ON position

Note. If sufficient load is not applied, it is possible for a PSU front panel power LED to be GREEN and the power good+output to be LOW (alarm state), in this case the power supply will not be registered by the **ViaLiteHD** control cards.

3.5 Connecting to the rear relay connections

The pin out of the rear 6 way connector is given in section 2.3.1. The connector can be used with wire gauges 14 . 22 AWG.

To insert a wire follow the sequence below.

1. Strip the wire leaving approximately 10mm of exposed copper
2. Tightly twist all strands together
3. Push the latch at the top of the connector back with a small flat bladed screw driver
4. With the latch held in, insert the wire
5. Push the wire home then release the catch

To release a wire follow the sequence below.

1. Push the latch at the top of the connector back with a small flat bladed screw driver
2. With the latch held in, pull the wire from the connector
3. Release the catch

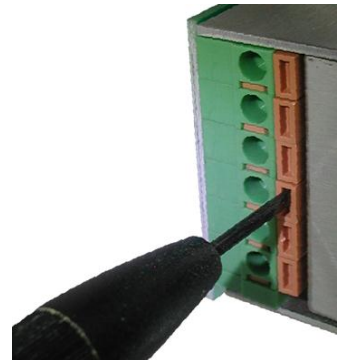

4 System Integration

4.1 Initial set up equipment

For initial set up you will require:

- A small flat bladed screw driver (1.8mm to 3.0mm tip) to actuate DIP switches
- A small flat bladed screw driver (1.8mm to 3.0mm tip) to push the catch of the 6 way relay connector
- Wire cutters and stripper to prepare wires for insertion into the 6 way relay connector
- Suitable stranded 14 . 22 AWG wire to interface to the 6 way relay connector

Full set up details are given in section 3

4.2 Site requirements

The site will require the following services, to make full use of the *ViaLiteHD* equipment:

- Power source of rack chassis
- 19+enclosure
- Interface cables / patch panels

5 Mechanical Dimensions



Weight: 260g Typical

6 Part Numbering

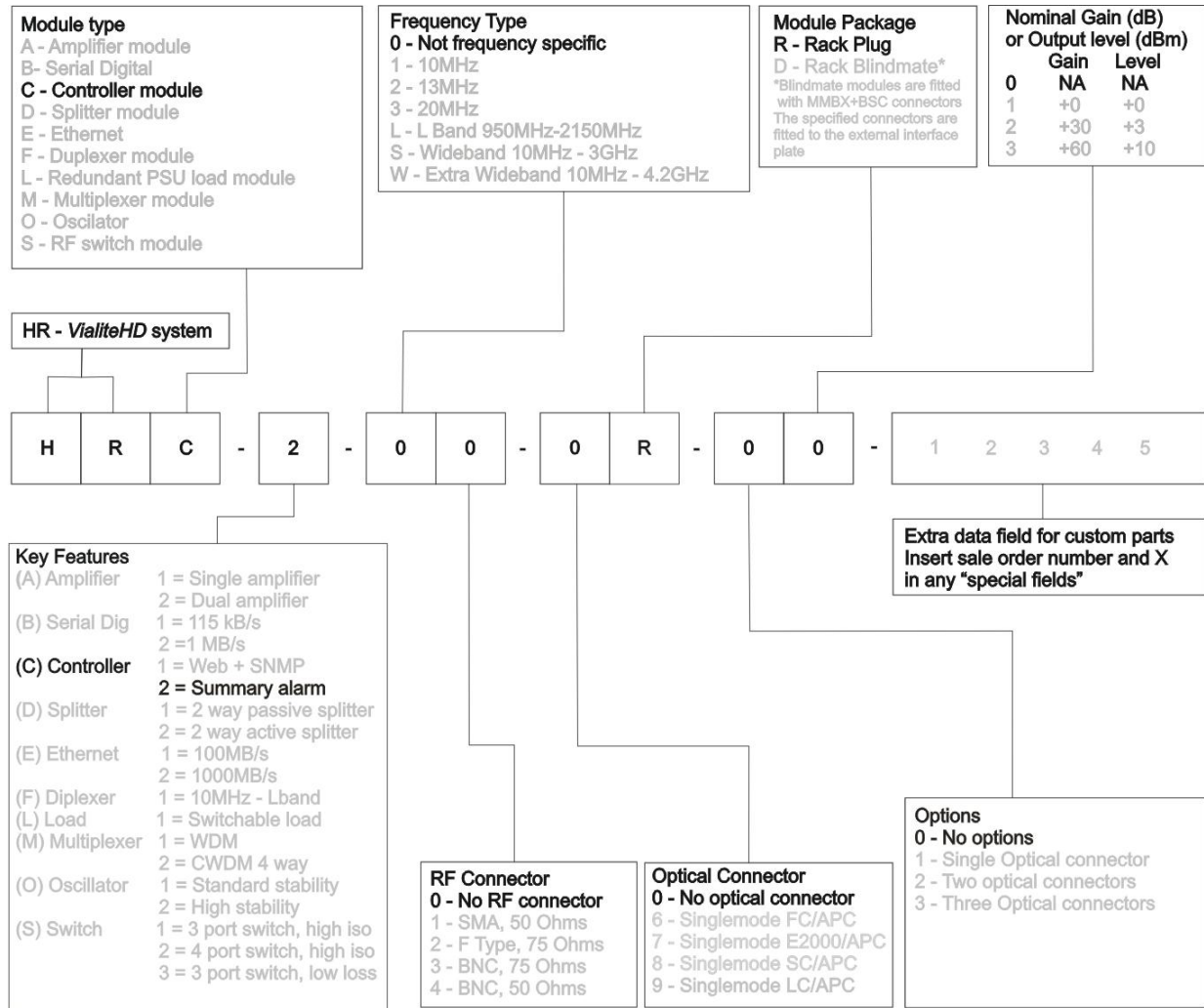

Note: Options relevant to the SNMP module are shown in **DARK** type option in **LIGHT** type are not available for this module
 Not all combinations of options are available. Contact PPM for more details.

7 Technical Specifications

Module function	Summary alarm
Format	Plug in module compatible with ViaLiteHD rack chassis, 7HP slot
Indicators	Front panel %Power+LED (GREEN) Front panel %Status+LED (GREEN/RED)+ Front panel %Load on+LED (GREEN)
Plug-in module electrical signal/power connector	User accessible via 19+Rack chassis backplane

Operating Conditions

Module operating voltage	+12V \pm 0.5V
Module operating voltage and power	1W Typical, excluding resistive load
Operating temperature	-10°C to +50°C
Storage temperature	-40°C to +70°C
Ambient relative humidity	10% to 95% (Non Condensing)
Maximum weight	300g

Electrical load

Control	DIP switch selection, 4 switches, 3 watts per switch
Electrical load	0/ 3/ 6/ 9/ 12 watts

Alarm monitoring

Manual masking	DIP switch selection
Automatic masking	via I2C sensing at start up
Alarm sensing	via backplane open collector alarm, 13 modules plus 2 power supplies
Buzzer frequency	2.4kHz

Rear relay port

Connector type	Screw less, 6 terminal connector
Wire gauge	14 . 22 AWG, 0.33 . 2.08 mm ²

Relay

Relay Type	Form C break before make, dry contact, volt free
Relay ports	Relay 1: COM 1 (common), NO 1 (normally open), NC 1 (normally closed) Relay 2: COM 2 (common), NO 2 (normally open), NC 2 (normally closed)
Maximum voltage	50V any terminal relative to ground
Maximum current	1A
Initial contact resistance	75 m

8 Maintenance and Fault-Finding Guide

Refer to the following table that gives a list of commonly encountered problems and suggested solutions.

Fault	Possible Causes	Solution
PWR LED does not light	Power source not connected.	Connect power source.
Status LED is flashing RED Buzzer is sounding	A connected modules has an ALARM	Fix alarming module OR Press the front panel switch to ACKNOWLEDGE the alarm. This will mute the buzzer and change status LED to solid RED
Status LED is solid RED	A connected modules has an ALARM	The alarm has already been acknowledged.

The *ViaLiteHD* range is precision engineered and calibrated for optimum performance and accuracy before dispatch.

In the event of any problems or queries arising with the equipment, please contact PPM or your local agent.

9 Glossary

A	Ampere
AGC	Automatic gain control
BUC	Block up converter
CNR	Carrier to noise ratio
COM	Common
dB	Decibel
dBc	Decibel relative to carrier
dBm	Decibel milli watt
DC	Direct current
DHCP	Dynamic host configuration Protocol
DIP	Dual in line (package)
DVB	Digital video broadcast
DVB-T	Digital video broadcast terrestrial
FC/APC	Fibre connector angled polished contact
FC/PC	Fibre connector physical contact
FOL	Fibre optic link
FSK	frequency shift keying
FTP	File transfer protocol
g	Gram
GHz	Giga hertz
GPS	Global positioning system
GRN	Goods Return Number
GUI	Graphical user interface
HRK3	ViaLiteHD 3U rack chassis
HTML	Hypertext mark-up language
HP	Rack hole pitch measurement of width 5.08mm
Hz	Hertz
I2C	Inter-Integrated circuit bus
IMD	Intermodulation distortion ratio
IP	Internet protocol
IP3	Third order intercept point
kg	Kilo gram
kHz	Kilo hertz
LAN	Local area network
LASER	Light amplification by stimulated emission of radiation
LC/PC	Lucent connector physical contact
LED	Light emitting diode
LNA	Low noise amplifier
LNB	Low noise block
m	Metre
mA	Milli ampere
Max	Maximum
MHz	Mega hertz
Min	Minimum
mm	Milli metre
mV	Milli volt
NC	Normally closed
NF	Noise figure
nm	Nano meter
NO	Normally open
P1dB	Power at one decibel gain compression
PC	Personal computer
PPM	Pulse power and measurement Ltd
PWR	Power
RF	Radio frequency
RLL	Received light level
RST	Reset
RX	Receiver
SC/APC	Subscriber connector angled polished contact
SC/PC	Subscriber connector physical contact
SFDR	Spurious free dynamic range
SINAD	Signal to noise and distortion ratio
SNMP	Simple network management protocol
TCP/IP	Transmission Control Protocol
TRX	Transceiver
TX	Transmitter
Typ	Typical
U	Rack units measurement of height 44.45mm
V	Voltage select
VSEL	Voltage select
VSWR	Voltage standing wave ratio
W	Watt

10 Product Warranty

PPM guarantees its products, and will maintain them for a period of three years from the date of shipment and at no cost to the customer. Extended warranty options are available at the time of purchase.

Please note that the customer is responsible for shipping costs to return the module to PPM.

PPM or its agents will maintain its products in full working order and make all necessary adjustments and parts replacements during the Company's normal working hours provided that the Customer will pay at the rates currently charged by the Company for any replacements made necessary by accident, misuse, neglect, wilful act or default or any cause other than normal use.

Claims must be made promptly, and during the guarantee period.

IMPORTANT: -

Please contact both your selling agent and PPM prior to returning any goods for Warranty or Non-Warranty repairs. Goods will not be accepted without a valid Goods Return Number (GRN)

© PULSE POWER & MEASUREMENT LTD 2011.

NO PART OF THIS DOCUMENT MAY BE REPRODUCED OR TRANSMITTED IN ANY FORM WITHOUT PRIOR WRITTEN PERMISSION.

PPM, 65 SHRIVENHAM HUNDRED BUSINESS PARK, SWINDON, SN6 8TY, UK.

TEL: +44 1793 784389 FAX: +44 1793 784391

EMAIL : SALES@PPM.CO.UK

WEBSITE : WWW.VIALITE.COM